

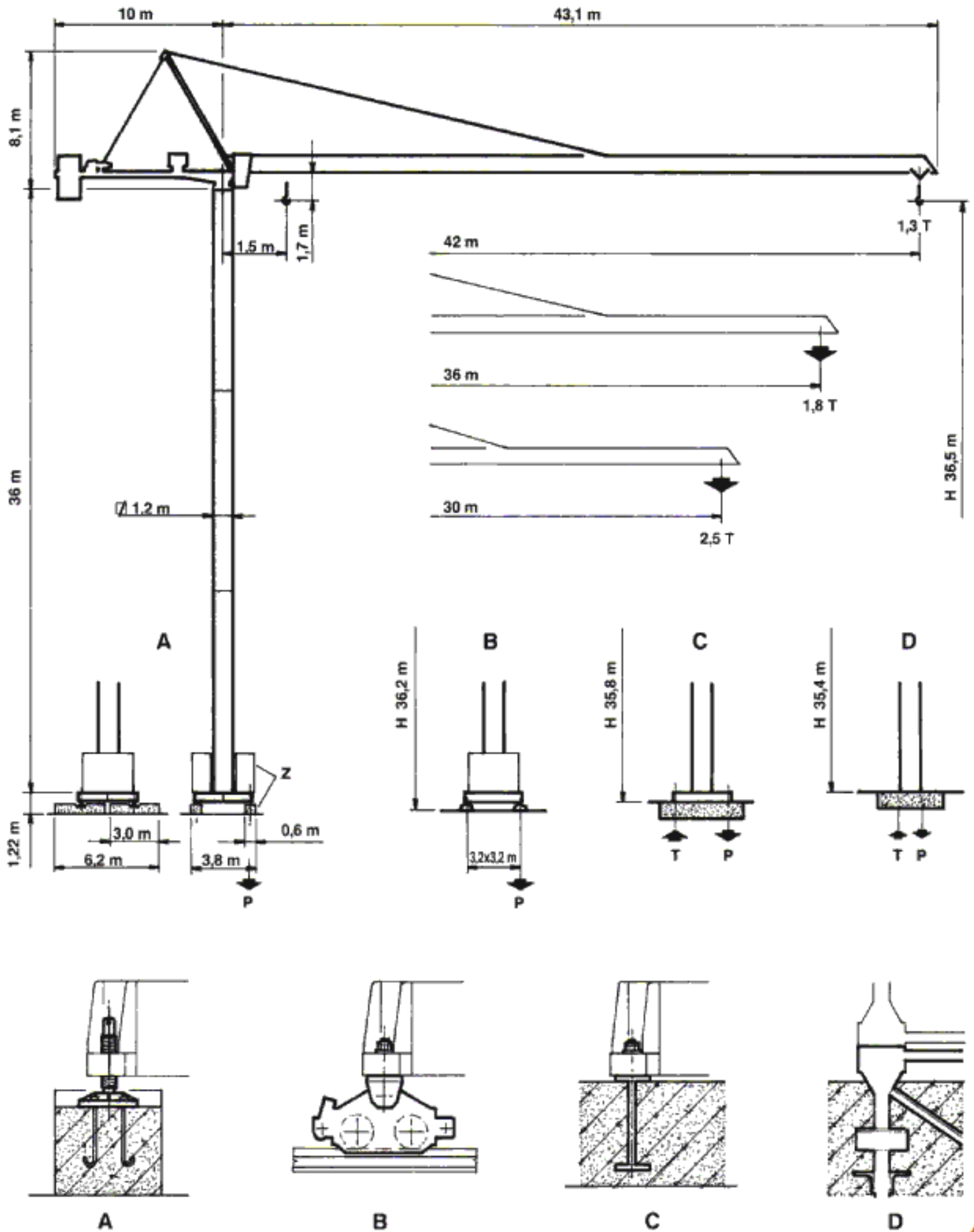





RAIVAN MR 60



FAST ERECTION TOWER CRANE

VANSON



Max. s.w.l.		3000 kg. 			5000 kg.  / 2500 kg. 		
Jib	m.	30	36	42	30	36	42
Max s.w.l. range from+to	m	1,5+25,5	1,5+23,2	1,5+20,7	1,5+15,9	1,5+14,5	1,5+13,1
Radii (m.) and s.w.l. (kg.)	12	3000	3000	3000	5000	5000	5000
	14	3000	3000	3000	5000	5000	4620
	16	3000	3000	3000	4980	4480	3960
	18	3000	3000	3000	4360	3910	3460
	20	3000	3000	3000	3860	3460	3050
	22	3000	3000	2790	3460	3100	2730
	24	3000	2880	2460	3130	2800	2460
	26	2940	2630	2310	2850	2540	2230
	28	2690	2400	2110	2610	2320	2030
	30	2500	2230	1950	2400	2140	1870
	32		2060	1815		1970	1720
	34		1920	1680		1830	1590
	36		1800	1570		1700	1480
	38			1470			1370
40			1380			1280	
42			1300			1200	

	Speed	Power
	0,37 0,7 1 r.p.m.	6,5 HP 4,7 KW
	18,8 35,2 54 m/min	5,5 HP 4 KW
	20 m/min	2x3 HP 2x2,2 KW

Hoisting winch	25 HP (18,4 kW)	25 HP (18,4 kW)
	Load / Speed	Load / Speed
	1 2500 kg. / 8,8 m/min	3000 kg. / 7,5 m/min
	2 2500 kg. / 35 m/min	3000 kg. / 30 m/min
	3 1250 kg. / 70 m/min	1500 kg. / 60 m/min
	1 5000 kg. / 4,4 m/min	—
	2 5000 kg. / 17,5 m/min	—
	3 2500 kg. / 35 m/min	—

A				B				C				D					
H	Z	P		H	Z	P		H	P		T		H	P		T	
m.	t.	i.s. t.	f.s. t.	m.	t.	i.s. t.	f.s. t.	m.	i.s. t.	f.s. t.	i.s. t.	f.s. t.	m.	i.s. t.	f.s. t.	i.s. t.	f.s. t.
36,5	49,5	38,2	41,7	36,2	49,5	38,1	41,6	35,8	24,6	28,5	11,3	14,4	35,4	58,5	68,7	45,9	55,7
30,5	49,5	36,0	34,4	30,2	49,5	35,9	34,3	29,8	22,7	21,3	9,9	7,8	29,4	53,5	48,2	41,6	35,8
24,5	49,5	34,1	28,3	24,2	49,5	34,0	28,2	23,8	20,9	15,3	8,8	2,4	23,4	49,1	31,1	37,7	19,4
18,5	49,5	32,4	22,6	18,2	49,5	32,4	22,6	17,8	19,4	9,3	7,8	—	17,4	45,2	12,7	34,5	1,6
12,5	39,6	28,5	15,5	12,2	39,6	28,5	15,5	11,8	17,7	6,1	7,0	—	11,4	41,5	7,4	32,1	—